



	<p>1. SHOWCASE SHELVES</p> <p>length x width x height (cm)</p> <p>a) 100 x 100 x 250 b) 50 x 100 x 250 c) 70 x 70 x 250 d) 50 x 50 x 250</p>	<p>pcs</p> <hr/> <p>-55 €</p>
---	---	--------------------------------------

	<p>2. LOW SHOWCASE</p> <p>length x width x height (cm)</p> <p>a) 100 x 100 x 100 b) 50 x 100 x 100 c) 70 x 70 x 100 d) 50 x 50 x 100</p>	<p>pcs</p> <hr/> <p>-37 €</p>
---	---	--------------------------------------

	<p>3. ILLUMINATED PLEXIGLASS POST</p> <p>length x width x height (cm)</p> <p>a) 100 x 100 x 250 b) 50 x 100 x 250 c) 70 x 70 x 250 d) 50 x 50 x 250</p>	<p>pcs</p> <hr/> <p>-82 €</p>
---	--	--------------------------------------

	<p>4. WALL UNIT WITH 3 SHELVES</p> <p>length x width x height (cm)</p> <p>a) 100 x 100 x 250 b) 50 x 100 x 250 c) 70 x 70 x 250 d) 50 x 50 x 250</p>	<p>pcs</p> <hr/> <p>-33 €</p>
---	---	--------------------------------------

	<p>5. WALL UNIT: TRIANGLE, PLANE, WORKING SURFACE</p> <p>length x width x height (cm)</p> <p>a) 100 x 100 x 250 b) 50 x 100 x 250 c) 70 x 70 x 250 d) 50 x 50 x 250</p>	<p>pcs</p> <hr/> <p>-10 €</p>
--	--	--------------------------------------



	<p>6. INCLINED SHELVES</p> <p>length x width (cm)</p>	<p>pcs</p> <hr/> <p>-6 €</p>
--	--	-------------------------------------

	<p>7. LOCKER WITH KEY</p> <p>length x width x height (cm)</p> <p>100 x 500 x 80</p>	<p>pcs</p> <hr/> <p>-32 €</p>
---	--	--------------------------------------

	<p>8. PEDESTAL PANEL</p> <p>length x width (cm)</p> <p>a) 100 x 100 b) 50 x 100 c) 70 x 70 d) 50 x 50</p>	<p>pcs</p> <hr/> <p>-13 €</p>
---	--	--------------------------------------

	<p>9. INFO COUNTER</p> <p>length x width x height (cm)</p> <p>a) 100 x 50 x 80 b) 100 x 50 x 100 c) 100 x 50 x 120</p>	<p>pcs</p> <hr/> <p>-26 €</p>
---	---	--------------------------------------

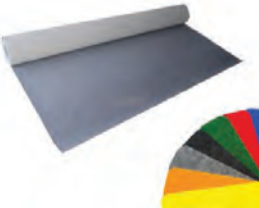
	<p>10. BAR COUNTER</p> <p>length x width x height (cm)</p> <p>a) 100 x 100 x 120 b) 50 x 100 x 120 c) 70 x 70 x 120 d) 50 x 50 x 120</p>	<p>pcs</p> <hr/> <p>-30 €</p>
---	---	--------------------------------------

	<p>11. CARPET</p> <p>color</p> 	<p>m²</p> <hr/> <p>-7 €</p>
---	---	---

	<p>12. CEILING RASTER</p>	<p>m²</p> <hr/> <p>-15 €</p>
---	----------------------------------	--

	<p>13. CEILING SCREEN FOR INSCRIPTION AND ILLUMINATION</p>	<p>m²</p> <hr/> <p>-15 €</p>
---	---	--

	<p>14. ACCORDION DOOR WITH KEY</p>	<p>pcs</p> <hr/> <p>-28 €</p>
---	---	--------------------------------------

	<p>15. PARTITION WALL</p> <p>length x width (cm)</p> <p>a) 100 x 250 b) 50 x 250 c) 70 x 250 d) 50 x 250</p>	<p>pcs</p> <hr/> <p>-21 €</p>
---	---	--------------------------------------

	<p>16. PARTITION WALL</p> <p>double construction or with upgrade</p>	<p>pcs</p> <hr/> <p>-27 €</p>
---	---	--------------------------------------

	<p>17. GLASS PARTITION WALL</p> <p>length x width (cm)</p> <p>a) 100 x 100 x 250 b) 50 x 100 x 250 c) 70 x 70 x 250 d) 50 x 50 x 250</p>	<p>pcs</p> <hr/> <p>-27 €</p>
---	---	--------------------------------------

	<p>18. PARTITION WALL METAL GRID</p> <p>length x height (cm)</p> <p>a) 100 x 250 b) 50 x 250 c) 70 x 250</p>	<p>pcs</p> <hr/> <p>-22 €</p>
---	---	--------------------------------------

	<p>19. TABLE</p> <p>a) Ø 80 cm</p>	<p>pcs</p> <hr/> <p>-17 €</p>
--	---	--------------------------------------

	<p>20. TABLE</p> <p>b) 80/80 cm</p>	<p>pcs</p> <hr/> <p>-17 €</p>
--	--	--------------------------------------

	<p>21. TABLE</p> <p>c) 120/80 cm</p> <p>Color wood white</p>	<p>pcs</p> <hr/> <p>-17 €</p>
---	---	--------------------------------------

	<p>22. TABLE</p> <p>e) 120/60cm</p>	<p>pcs</p> <hr/> <p>-17 €</p>
---	--	--------------------------------------

	<p>23. BAR TABLE</p> <p>Ø 60 cm</p>	<p>pcs</p> <hr/> <p>-14 €</p>
---	--	--------------------------------------

	<p>24. LOW TABLE</p> <p>a)</p>	<p>pcs</p> <hr/> <p>-13 €</p>
---	---------------------------------------	--------------------------------------

	<p>25. CHAIRS</p> <p>a)</p>	<p>pcs</p> <hr/> <p>-10 €</p>
---	------------------------------------	--------------------------------------

	<p>26. CHAIRS</p> <p>b)</p> <p>Color red blue grey</p>	<p>pcs</p> <hr/> <p>-12 €</p>
---	---	--------------------------------------

	<p>27. CHAIRS</p> <p>c)</p>	<p>pcs</p> <hr/> <p>-12 €</p>
---	------------------------------------	--------------------------------------

	<p>28. CHAIRS</p> <p>d)</p>	<p>pcs</p> <hr/> <p>-12 €</p>
---	------------------------------------	--------------------------------------

	<p>29. CHAIRS</p> <p>e)</p>	<p>pcs</p> <hr/> <p>-12 €</p>
---	------------------------------------	--------------------------------------

	<p>30. CHAIRS</p> <p>f)</p>	<p>pcs</p> <hr/> <p>-20 €</p>
---	------------------------------------	--------------------------------------

	<p>31. CHAIRS</p> <p>g)</p>	<p>pcs</p> <hr/> <p>-12 €</p>
---	------------------------------------	--------------------------------------

	<p>32. CHAIRS</p> <p>h)</p>	<p>pcs</p> <hr/> <p>-12 €</p>
---	------------------------------------	--------------------------------------

	<p>33. BAR CHAIR</p> <p>a)</p>	<p>pcs</p> <hr/> <p>-13 €</p>
--	---------------------------------------	--------------------------------------

	<p>34. BAR CHAIR</p> <p>b)</p> <p>Color white red blue</p>	<p>pcs</p> <hr/> <p>-12 €</p>
---	---	--------------------------------------

	<p>35. RATTAN SET</p> <p>1x table 2x armchair 1x sofa</p>	<p>pcs</p> <hr/> <p>-120 €</p>
---	--	---------------------------------------

	<p>36. WOODEN CHAIRS AND TABLE - SET</p> <p>4x chairs 1x table</p>	<p>pcs</p> <hr/> <p>-65 €</p>
---	---	--------------------------------------

	<p>37. SUNSHADE</p>	<p>pcs</p> <hr/> <p>-40 €</p>
---	----------------------------	--------------------------------------

	<p>38. ARMCHAIR</p> <p>a)</p>	<p>pcs</p> <hr/> <p>-27 €</p>
---	--------------------------------------	--------------------------------------

	<p>39. ARMCHAIR</p> <p>b)</p>	<p>pcs</p> <hr/> <p>-27 €</p>
---	--------------------------------------	--------------------------------------

	<p>40. STOOL</p>	<p>pcs</p> <hr/> <p>-13 €</p>
---	-------------------------	--------------------------------------

	<p>41. REFRIGERATOR</p>	<p>pcs</p> <hr/> <p>-43 €</p>
---	--------------------------------	--------------------------------------

	<p>42. KITCHEN SINK</p>	<p>pcs</p> <hr/> <p>-51 €</p>
---	--------------------------------	--------------------------------------

 <p>43. MINI KITCHEN</p>	pcs
	<hr/> <p>-120 €</p>

 <p>44. ICE MACHINE</p>	pcs
	<hr/> <p>-107 €</p>

 <p>45. COFFEE MACHINE a)</p>	pcs
	<hr/> <p>-187 €</p>

 <p>46. COFFEE MACHINE b)</p>	pcs
	<hr/> <p>-30 €</p>

 <p>47. WATER DISPENSER one water tank included</p>	pcs
	<hr/> <p>-53 €</p>

 <p>48. HANGER</p>	pcs
	<hr/> <p>-4 €</p>

 <p>49. CURTAIN</p>	pcs
	<hr/> <p>-7 €</p>

 <p>50. WASTE PAPER BASKET</p>	pcs
	<hr/> <p>-3 €</p>

 <p>51. DECORATIVE PIER WITH ROPES</p>	pcs
	<hr/> <p>-11 €</p>

 <p>52. SELF-SUPPORTIVE LEAFLET HOLDER</p>	pcs
	<hr/> <p>-48 €</p>

 <p>53. REFLECTOR a) 150 W b) 300 W</p>	pcs
	<hr/> <p>-19 € -28 €</p>

 <p>54. METAL -HALOGEN REFLECTOR (DIFFERENT SHAPES)</p>	pcs
	<hr/> <p>-41 €</p>

 <p>55. FLUO LAMP 60 W</p>	pcs
	<hr/> <p>-19 €</p>

 <p>56. SOCKET 220 W</p>	pcs
	<hr/> <p>-15 €</p>

 <p>57. ELECTRIC CABLES 5 x 1,5 mm²</p>	m
	-4 €

 <p>58. ELECTRIC CASE 5 - 10 kW <30 kW</p>	pcs
	-50 € -82 €

 <p>59. LAMINATE</p>	m ²
	-10 €

 <p>60. FLOOR STRUCTURE (PLATFORM) h=50 cm</p>	m ²
	-11 €

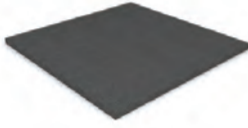
 <p>61. FLOOR STRUCTURE (PLATFORM) h=10 cm</p>	m ²
	-8 €

 <p>62. MAXIMA CONSTRUCTION 12x12cm 8x8cm 8x4cm 4x4cm</p>	m
	-21 €

 <p>63. ALLUMINIUM TRUSS CONSTRUCTION 30/30 - 40/40 cm triangular cubical</p>	m
	-16 €

 <p>64. LEXAN thickness 8-10mm</p>	m ²
	-27 €

 <p>65. WRAPPING UP WALLS WITH CHIPBOARD</p>	m ²
	-21 €













 <p>66. WRAPPING UP WALLS WITH LAMINATED CHIPBOARD IN COLOR color _____</p>	m ²
	-27 €

 <p>67. PAINTING WALLS WITH COLOURS color _____</p>	m ²
	-8 €

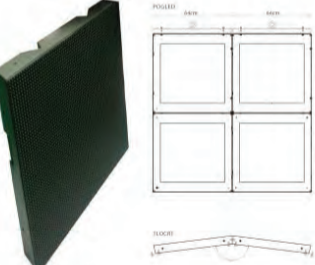
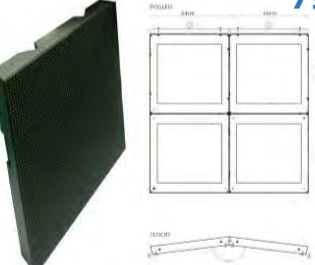
 <p>68. PAINTING WALLS WITH WHITE COLOUR</p>	m ²
	-7 €

 <p>69. ROTATING PLATFORM Ø 5 m</p>	pcs
	-685 €

 <p>70. STOREY STAND ELEMENTS</p>	m ²
	-93 €

 <p>71. INSCRIPTION with construction</p>	<p>pcs</p> <hr/> <p>-21 €</p>	 <p>72. INSCRIPTION IN LOGOTYPE with construction</p>	<p>pcs</p> <hr/> <p>-41 €</p>
 <p>73. GRAPHICS - PRINT</p>	<p>m²</p> <hr/> <p>-25 €</p>	 <p>74. MESH - TARPAULIN print, confection and set up</p>	<p>m²</p> <hr/> <p>18 €</p>
 <p>75. PLASMA TV 42" WITH CARRIER (1 DAY)</p>	<p>pcs</p> <hr/> <p>-47 €</p>	 <p>76. PLASMA TV 55" WITH WALL CARRIER (1 DAY)</p>	<p>pcs</p> <hr/> <p>-57 €</p>
 <p>77. PLASMA TV 65" WITH WALL CARRIER (1 DAY)</p>	<p>pcs</p> <hr/> <p>-67 €</p>	 <p>78. LED SCREEN SMD 3in1 Pitch resolution P 2.5 194x212 px internal per day</p>	<p>m²</p> <hr/> <p>-100 €</p>
 <p>79. LED EKRAN SMD 3u1 Resolution P 10 (10mm) 64x64 px flat and radial diameter of circle of 7m internal for all days of the fair</p>	<p>m²</p> <hr/> <p>67 €</p>	 <p>80. SOUNDSYSTEM TURBOSOUND 400W</p>	<p>pcs</p> <hr/> <p>-219 €</p>
 <p>81. CITYLIGHT DISPLAY self-supported, two sided</p>	<p>pcs</p> <hr/> <p>-96 €</p>	 <p>82. ADVERTISEMENT BOX</p>	<p>pcs</p> <hr/> <p>-48 €</p>
 <p>83. ILLUMINATED PLEXIGLAS ADVERTISEMENT BOX</p>	<p>pcs</p> <hr/> <p>-62 €</p>	 <p>84. ROTATING ILLUMINATED PLEXIGLAS ADVERTISEMENT BOX color _____</p>	<p>m²</p> <hr/> <p>-163€</p>